

BGE TEC's Work on Deep Borehole Disposal

Deep Borehole Disposal (DBD) Workshop – August 8-10, 2023

Tilman Fischer, Bernt Haverkamp, Toivo Wanne

Outline

1. WORK FOR NORWEGIAN NUCLEAR DECOMMISSIONING (NND)
 - development of the DBD work
2. TRL ASSESSMENT
3. EMPLACEMENT TECHNIQUES / OPTIONS
4. SAFETY ASSESSMENT

Radioactive Waste in Norway

- Responsible organization →  **NND**
NORSK NUKLEÆR DEKOMMISJONERING
- No commercial reactors, limited waste volume
- Radioactive waste from various industries and research reactors
- Disposal plan is to locate all needed repository types at a single site:
 - Landfill-type repository for VLLW
 - Intermediate-depth repository for LILW
 - HLW either in DGR-type (similar to Finland and Sweden) or Deep Borehole Disposal



Development of the DBD Work

1. General description of the concept (incl. drilling-related aspects, discussion of different waste canisters, borehole diameters)

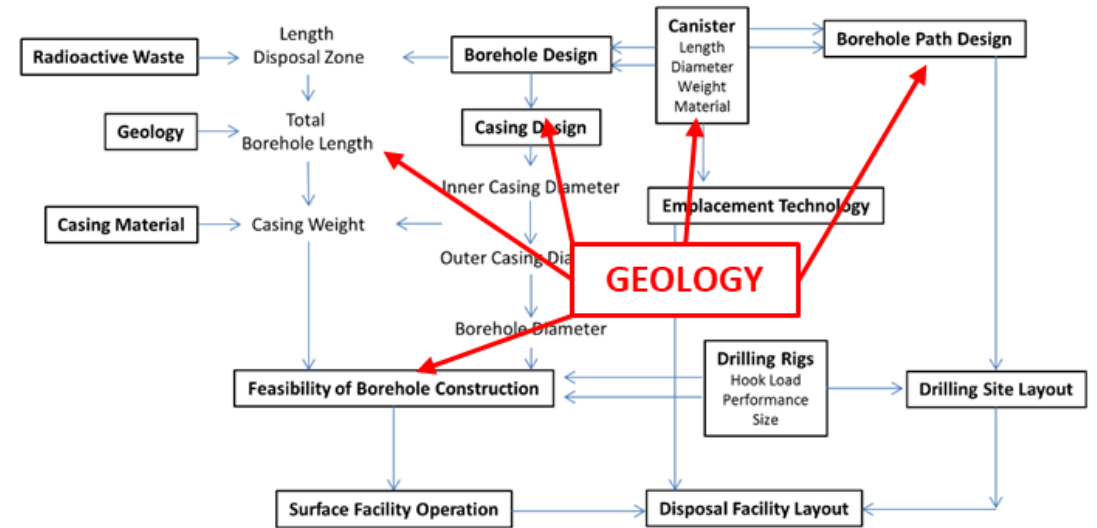

2. Description of important aspects when it comes to the sealing of boreholes (e.g. preparation of the borehole, material, material emplacement methods) and the dependency of the different aspects

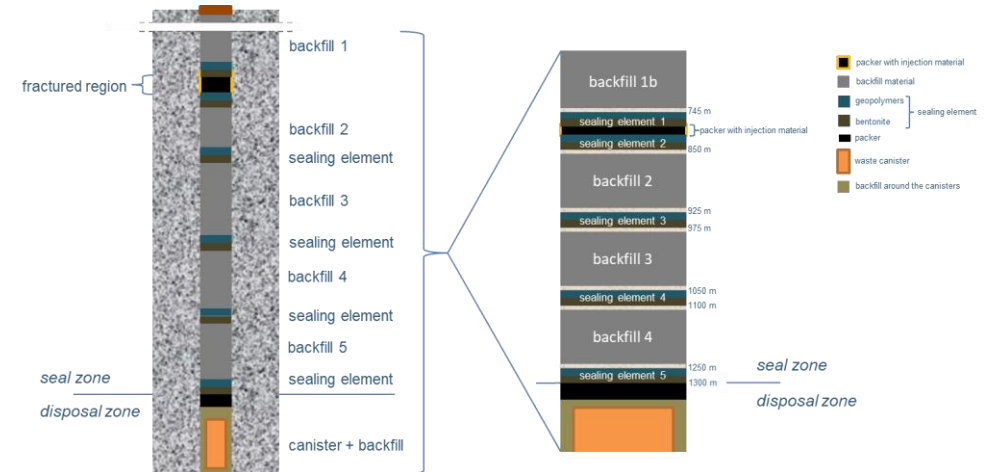

Development of the DBD Work

3. TRL evaluation

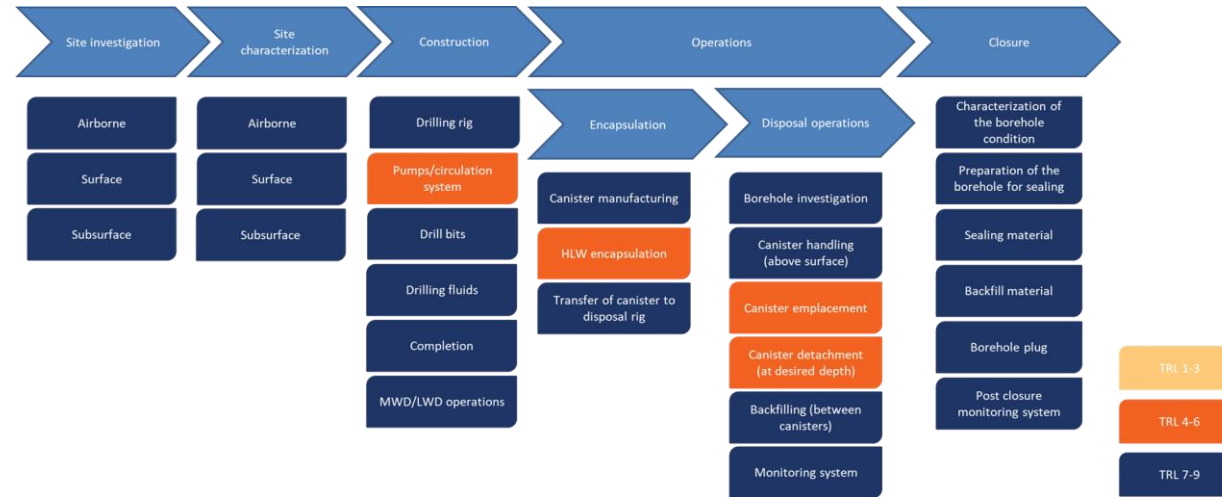

4. Design of a disposal canister

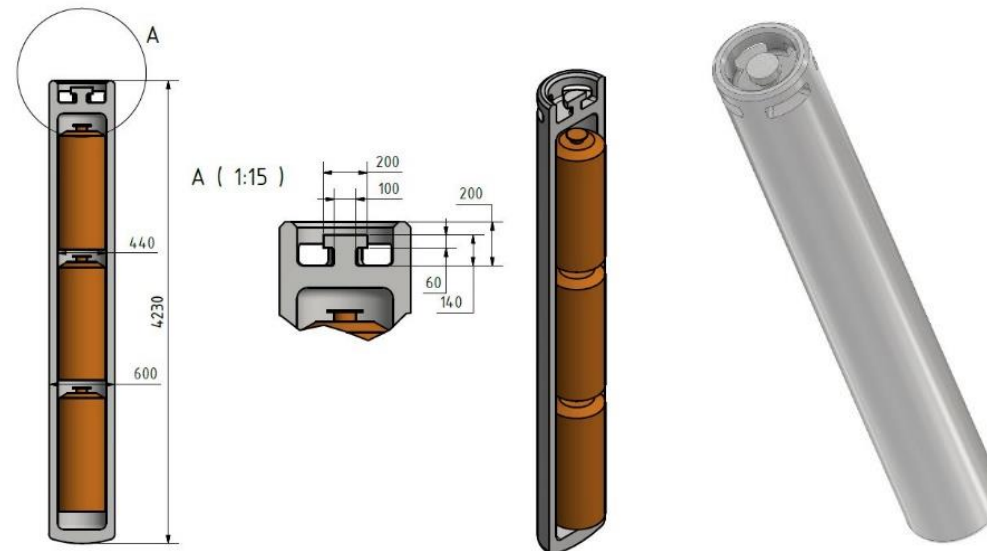

TRL Assessment

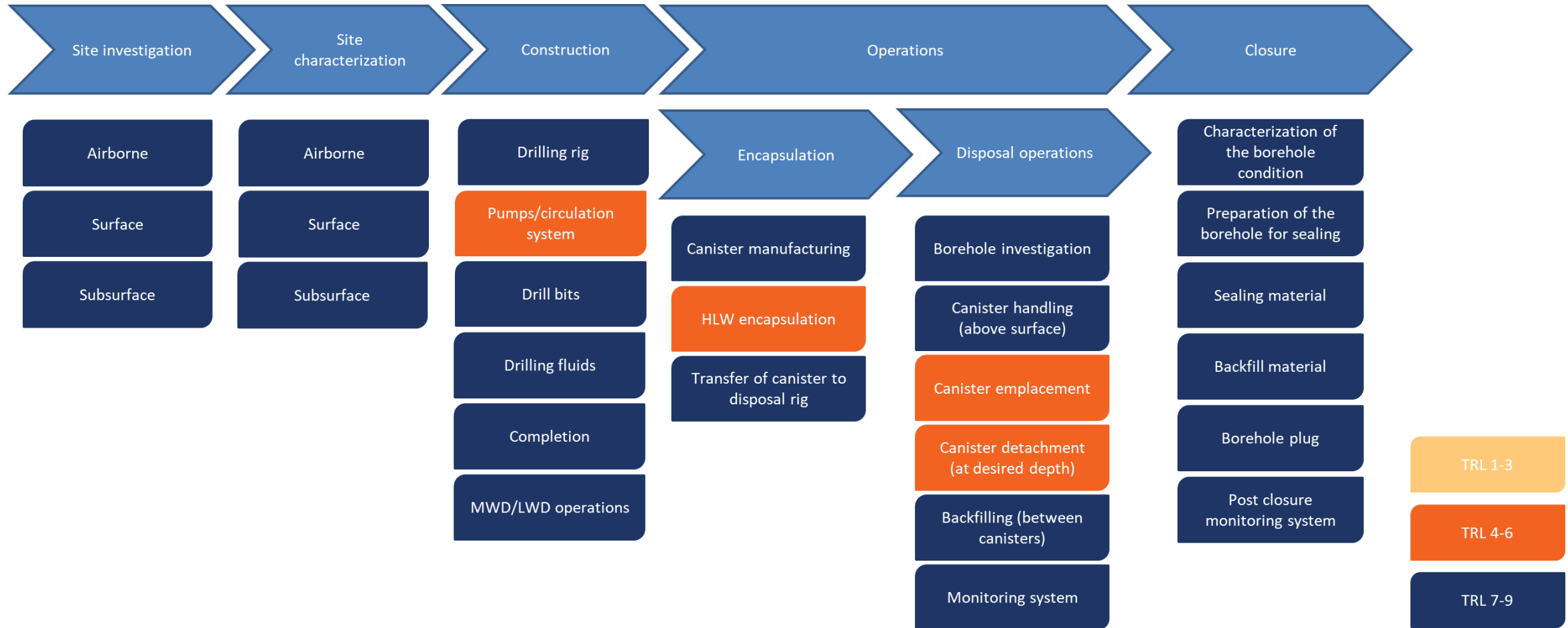

➤ Identification of aspects with the most R&D need

TRL Assessment

- Findings of the first TRL assessment:
 1. Site investigation/identification capabilities are available and applied on a daily basis
 2. Drilling capabilities are in principle available and have proven their usability, however, the “required” dimensions have not/barely been drilled so far
 - If looked at the technical feasibility, availability of the technologies and statements from drilling engineers, a borehole with the “required” dimensions can be drilled
 - The “right” components need to be put together
 3. Encapsulation plant, canisters, and emplacement device need to be developed

- In principle, all technologies are available and usable, but there is still a need for research to implement the DBD concept.

Emplacement Techniques

- Different options available:
 - Free fall (cannot be controlled → not feasible and thus not taken into account)
 - Shaft conveyor/hoisting systems
 - Drillstring
 - Wireline/coiled tubing
 - Special devices (e.g. DENKMAL emplacement device)

Emplacement Techniques



Construction site of Konrad 2 (shaft conveyor system)



HAS Innova Rig – H. Anger’s Söhne



NOV – Coiled tubing unit



NOV – Wireline logging truck

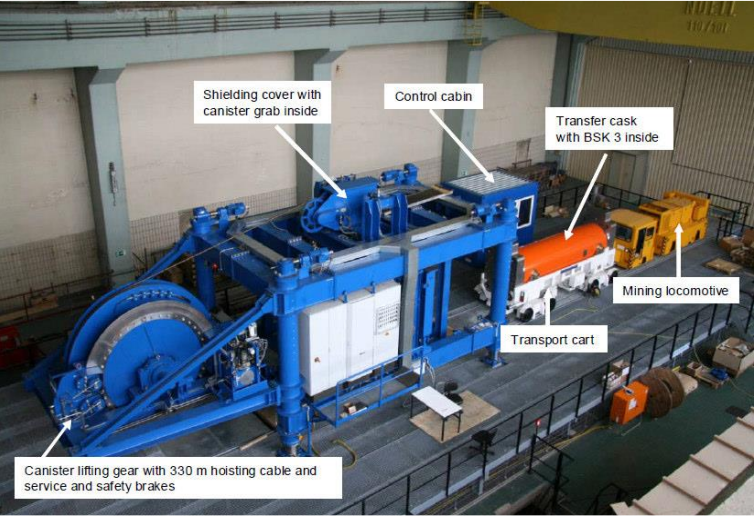

DENKMAL system

Emplacement Techniques - DENKMAL

- Technical sketch of the whole concept/system

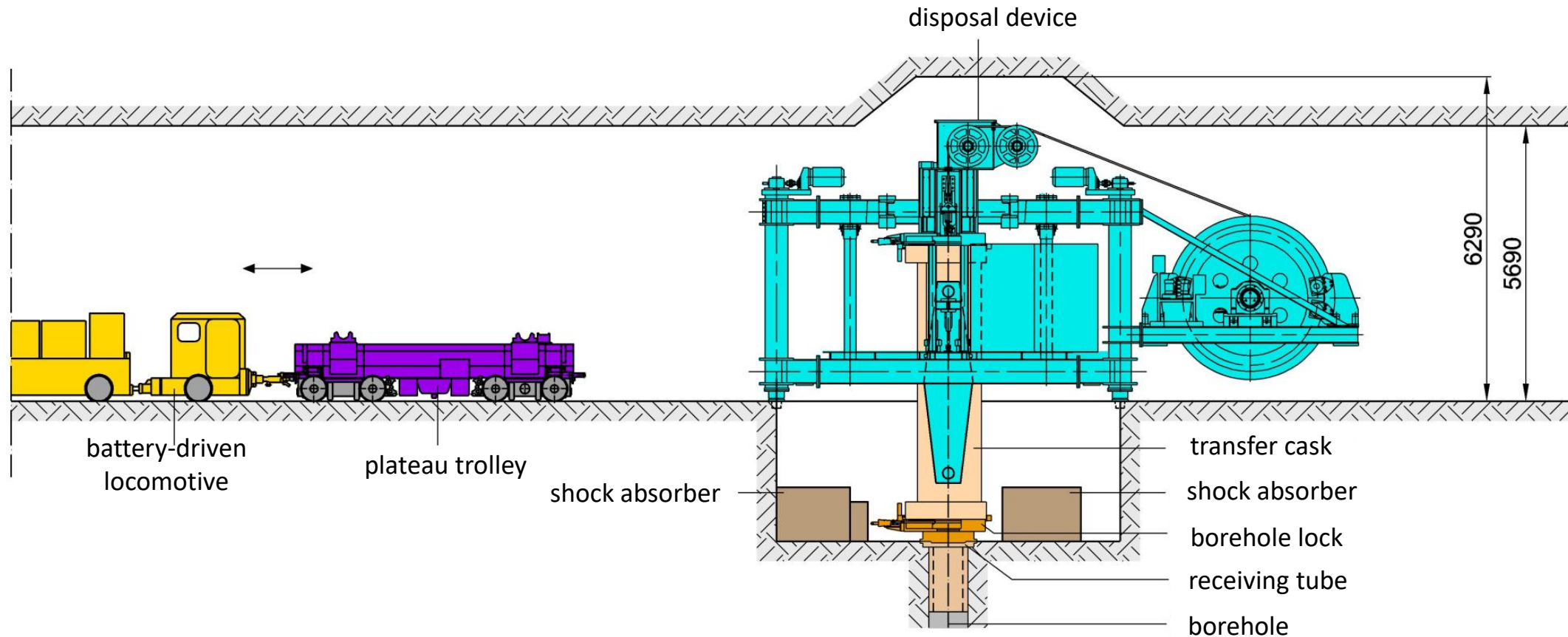

Emplacement Techniques - DENKMAL

- Transfer cask

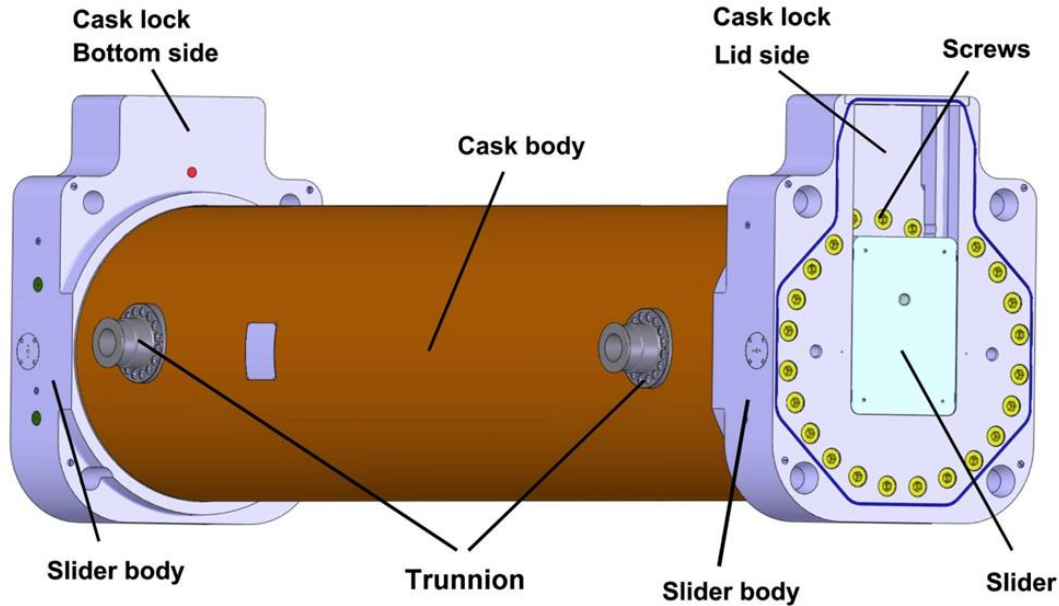

Technical data:

Length:	5.57 m
Diameter (cask body):	1.31 m
Height (cask lock):	1.89 m
Weight (incl. BSK 3):	52 tons



Emplacement Techniques - DENKMAL

- Borehole lock:

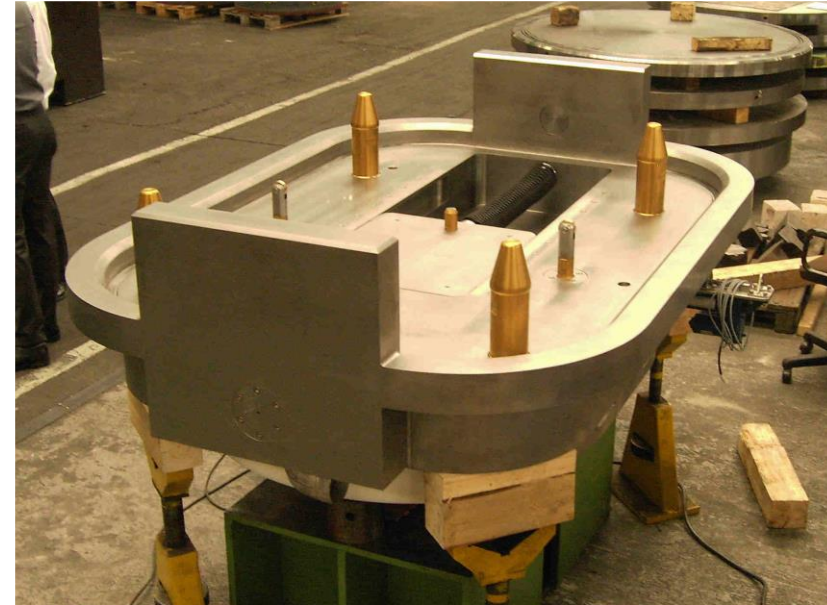
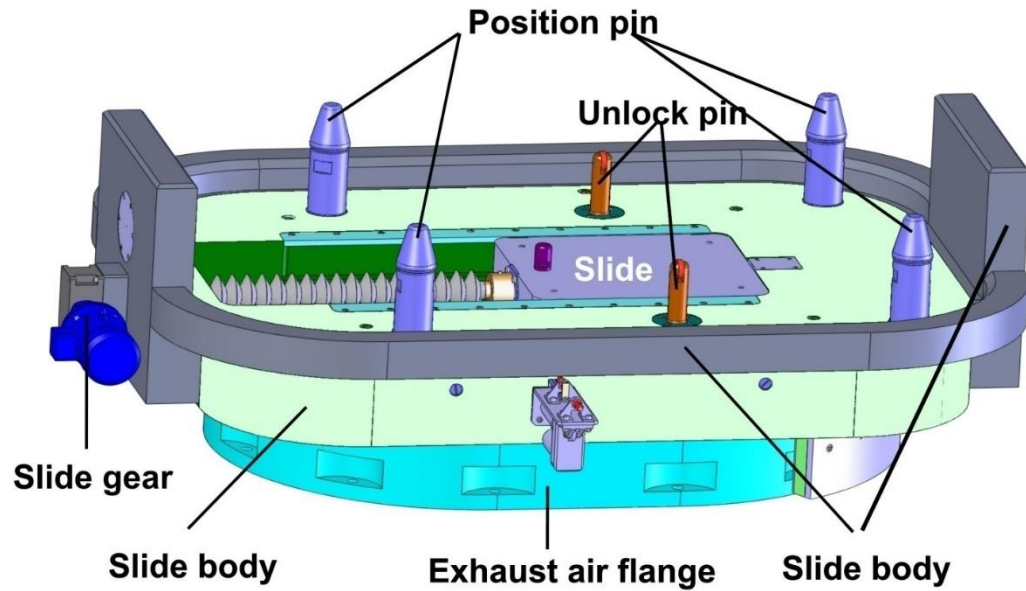

Technical data:

Length:	2.46 m
Width:	1.59 m
Height (cask lock):	0.55 m
Weight:	7.2 tons

Emplacement Techniques - DENKMAL

- Emplacement device:

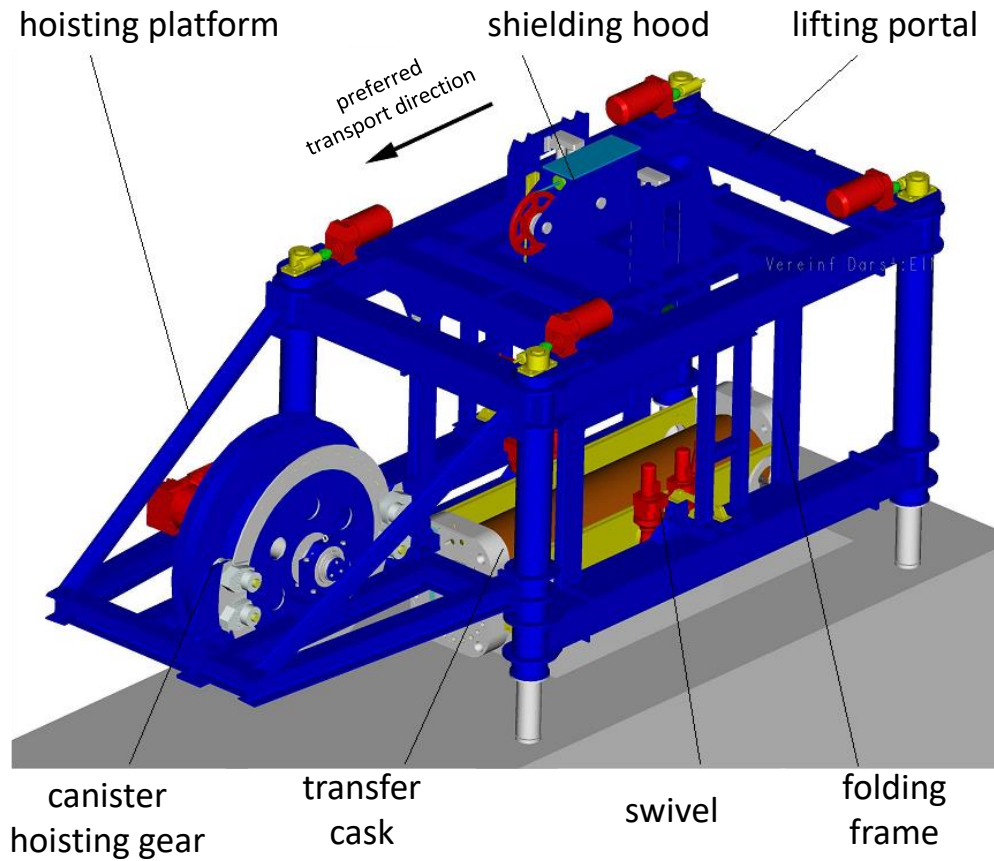

Technical data:

Maximal length: 12.2 m

Maximal width: 4.7 m

Maximal height: 6.5 m

Total weight: 66 tons

Emplacement Techniques

	Shaft conveyor/hoisting system	Drillstring	Wireline/coiled tubing	DENKMAL device
	Used on a daily basis in mining	Used on a daily basis in drilling operations (not for emplacement)	Used on a daily basis in drilling operations	Only a prototype specially designed to emplace radioactive waste was tested
	Large, permanent surface installations needed	Drilling rig required	No permanent system to be installed; truck-mounted system	Device is mobile and requires a relatively small surface area
	Potentially oversized and cost intensive	Cost intensive due to the rig rent	Easy to handle and low cost	Some more costly R&D work required
	Constructed to handle heavy loads		CT may handle heavy loads; WL potentially capable of handling waste canisters	Designed to handle loads of the waste canisters
	Do not provide a lock in the „standard system“			Prototype tests including lock carried out successfully
Lifting/lowering speed *	Konrad 1: 10.00 m/s Pyhäsalmi: 15.50 m/s	0.15 – 0.19 m/s	Wireline: 0.83 - 5.00 m/s Coiled tubing: 1.65 m/s	Max. 0.49 m/s

* example values

Safety Assessment

General information for the safety assessment

- Borehole assumptions:
 - Backfilling zone length: 2,500 m (backfill material is a crushed rock mixture)
 - Sealing zone length: 500 m (sealing consists of bentonite)
 - Disposal zone length: 460 m (88 canisters + 1 m bentonite buffer between the canisters)
- Canisters will fail, once thickness of canister walls has corroded from 80 mm initial thickness to 50 mm
- Calculations carried out with GoldSim

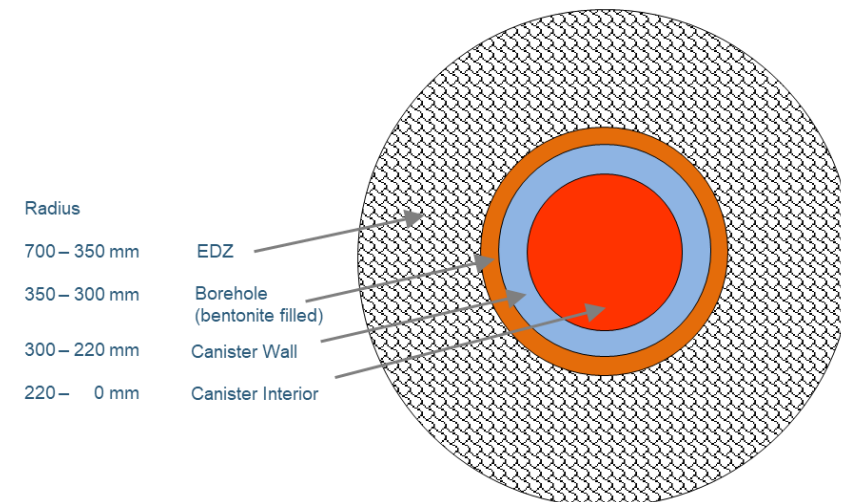

Safety Assessment

- Sealing zone has been divided into 25 segments
→ Each segments represents a 20-m-section
- Disposal zone has been divided into 22 segments
→ Each segment represents 4 canisters (21 m)
- Backfilling zone has been divided into 25 segments
→ → Each segment represents a 100-m-section

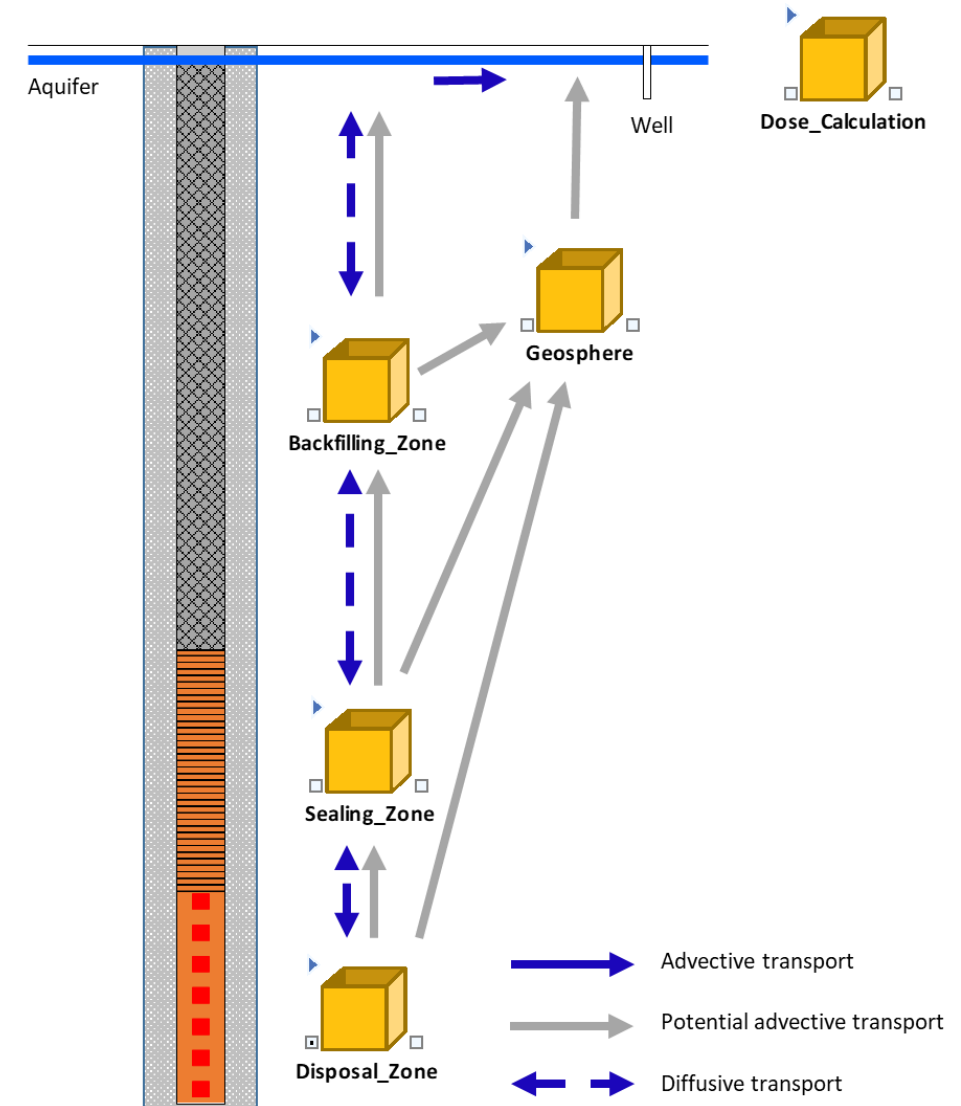

Safety Assessment – SC-1

Reference scenario - Normal Evolution Scenario – SC-1

- Only diffusive transport through the borehole and the damaged rock zone
- Advective transport through the groundwater aquifer to a water well

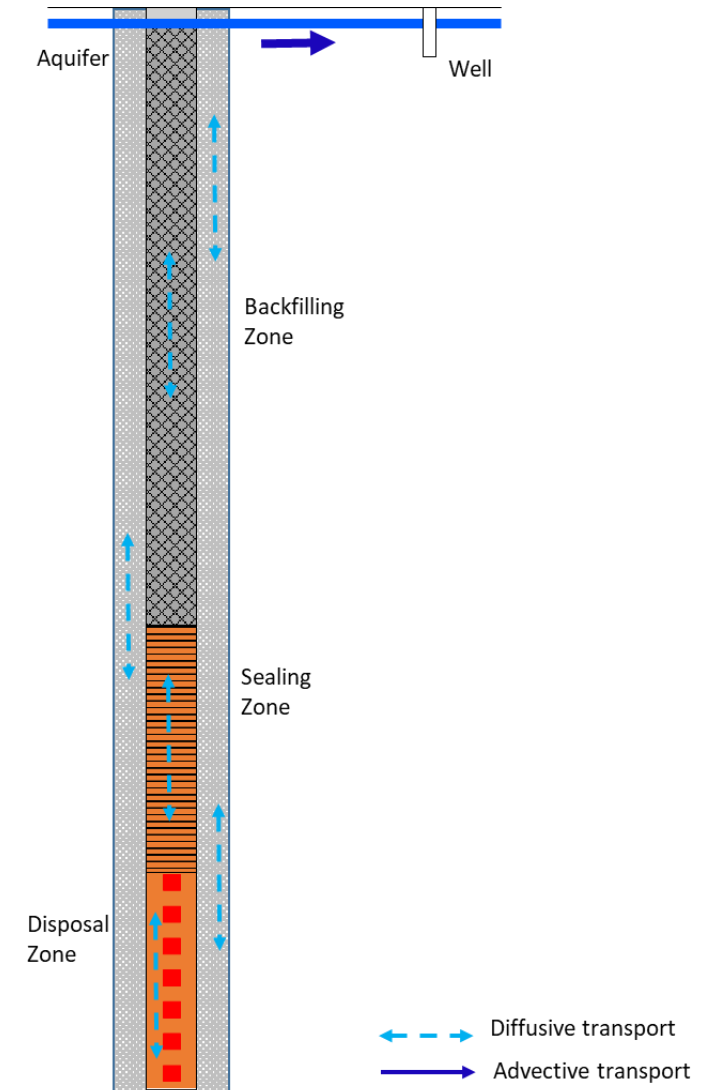

Safety Assessment – SC-1

Reference scenario - Normal Evolution Scenario – SC-1

- Only diffusive transport through the borehole and the damaged rock zone
- Advective transport through the groundwater aquifer to a water well

Results:

- Sorbing radionuclides or those with relatively short half-lives do not reach the top of the seal
- Even non-sorbing radionuclides hardly reach the backfilling zone and the aquifer

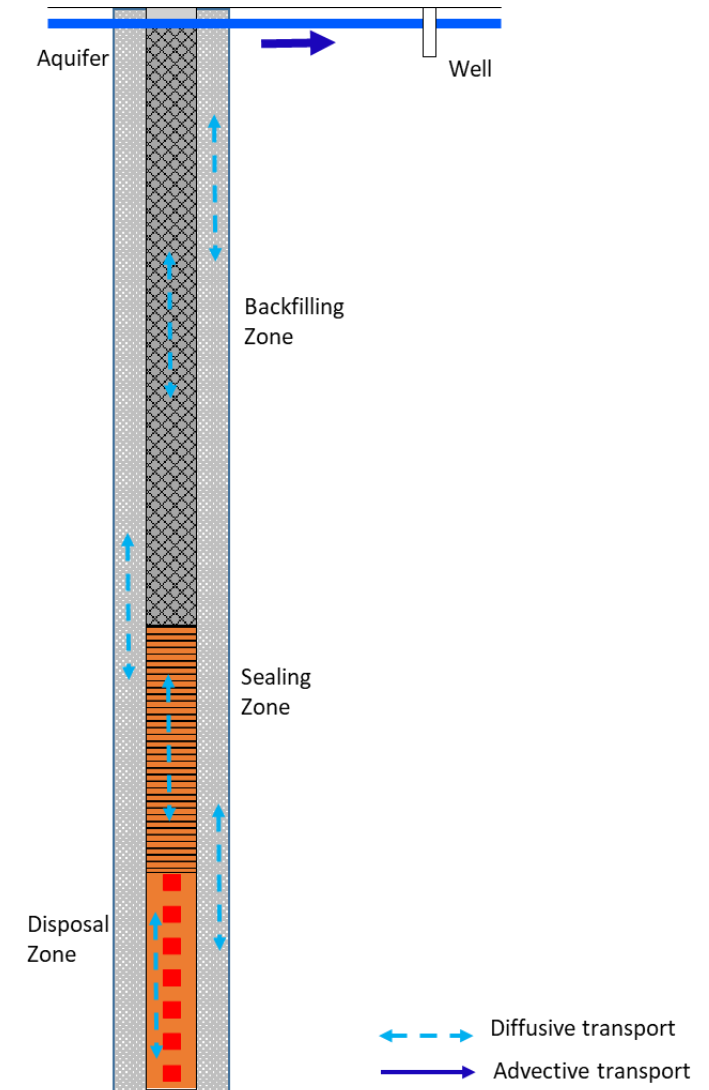
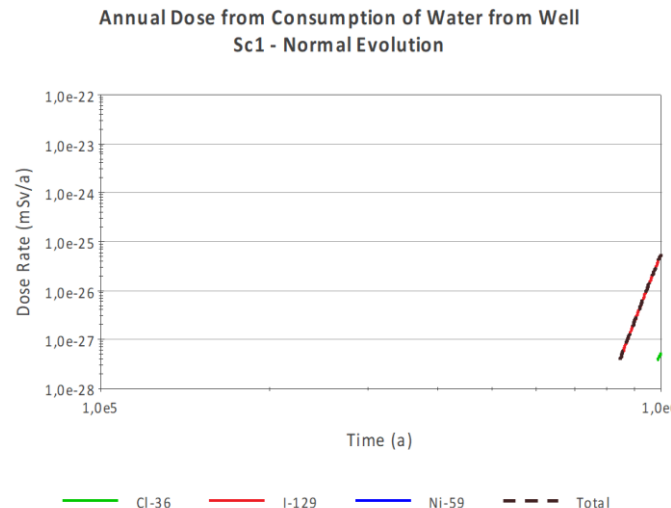

Safety Assessment – SC-2

Alternative scenario – Vertical Flow – SC-2

- Flow through the borehole and the damaged rock zone
- Different sub-scenarios considered
 - No solubility limits
 - No sorption
 - Direct failure of all canisters

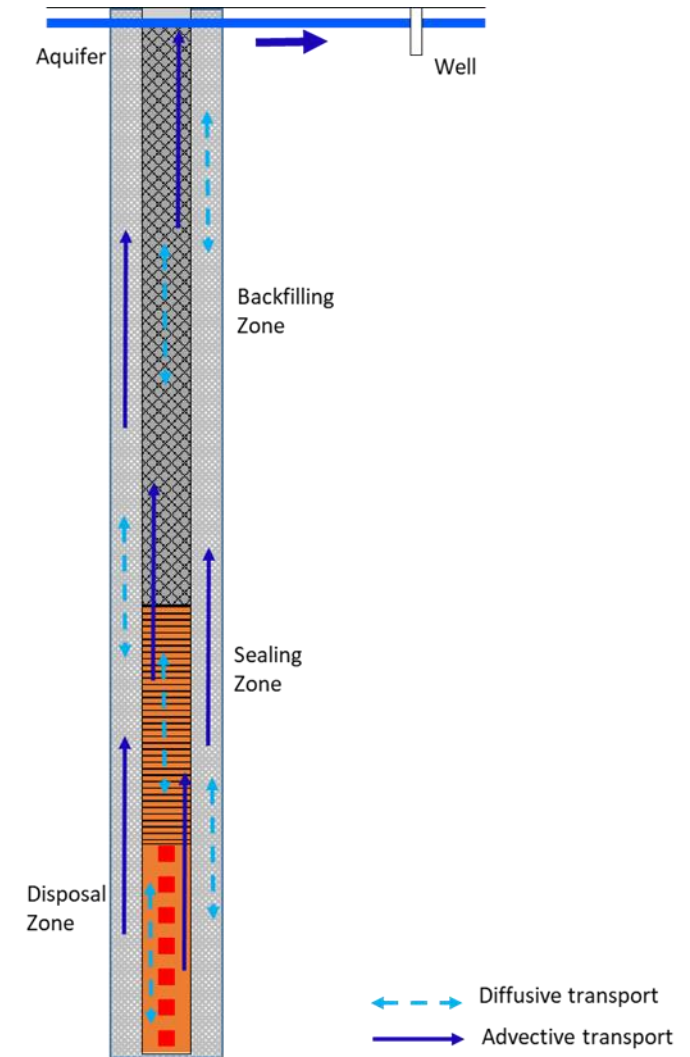

Safety Assessment – SC-2

Alternative scenario – Vertical Flow – SC-2

- Flow through the borehole and the damaged rock zone
- Different sub-scenarios considered
 - No solubility limits
 - No sorption
 - Direct failure of all canisters

Results:

- Compared to SC-1, the increase in dose rate is larger → advective transport is much more efficient than diffusive transport
- Total dose rate is higher
- Dose rate is still well below the assumed regulatory limit (0.1 mSv/a)

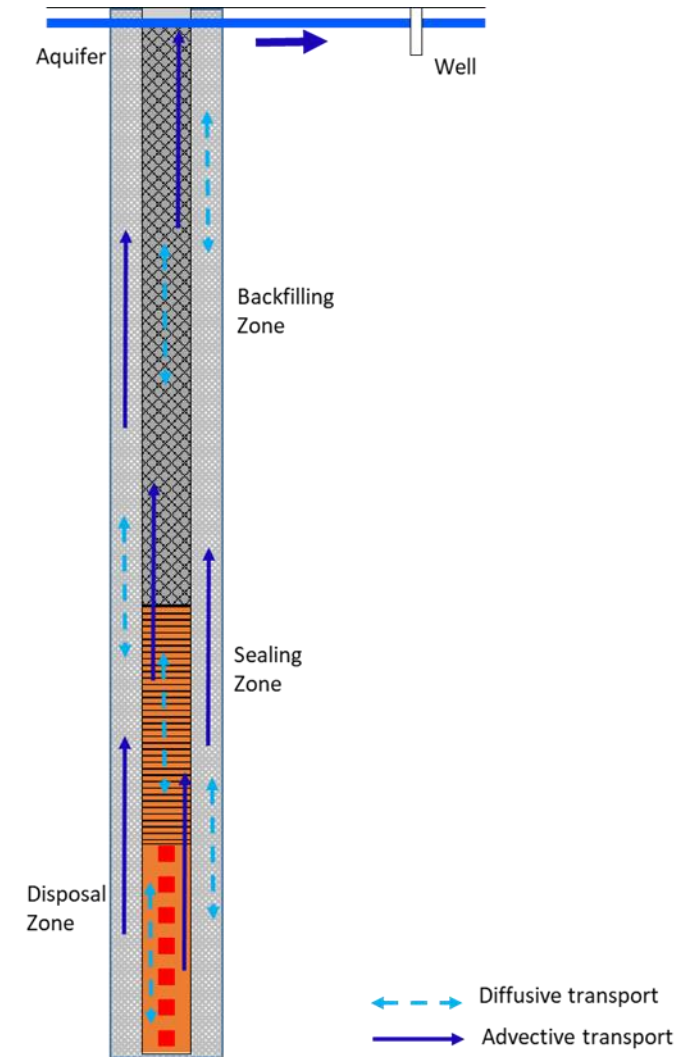

Safety Assessment – SC-3

Alternative scenario – Fracture – SC-3

- Flow through fractures
- Intersection of borehole by a highly transmissive fracture
- Fractures at different locations (depths) of the borehole considered:
 1. Bottom/middle/top of the disposal zone
 2. Middle of the sealing zone
 3. Bottom of the backfilling zone

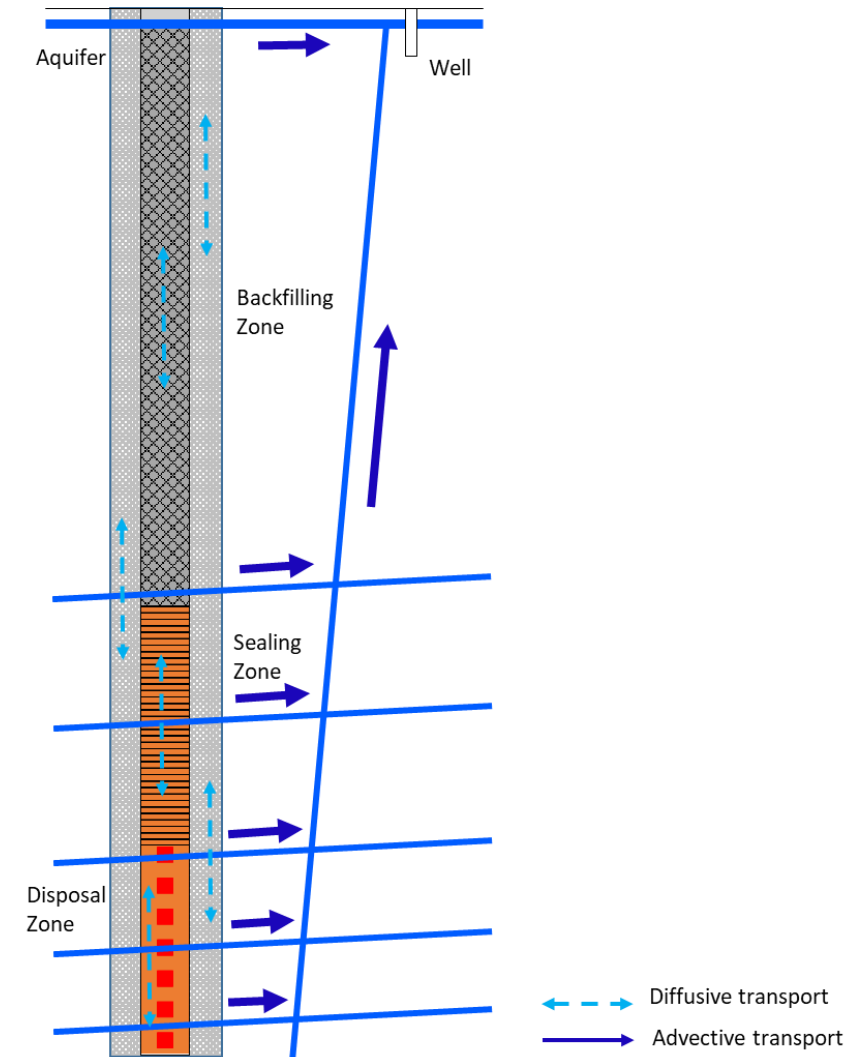

Safety Assessment – SC-3

Alternative scenario – Fracture – SC-3

- Flow through fractures
- Intersection of borehole by a highly transmissive fracture
- Fractures at different locations (depths) of the borehole considered:
 1. Bottom/middle/top of the disposal zone
 2. Middle of the sealing zone
 3. Bottom of the backfilling zone

Results:

- Dose rate depends strongly on the location of the fracture
- Higher dose rate than before, but still below the regulatory limits

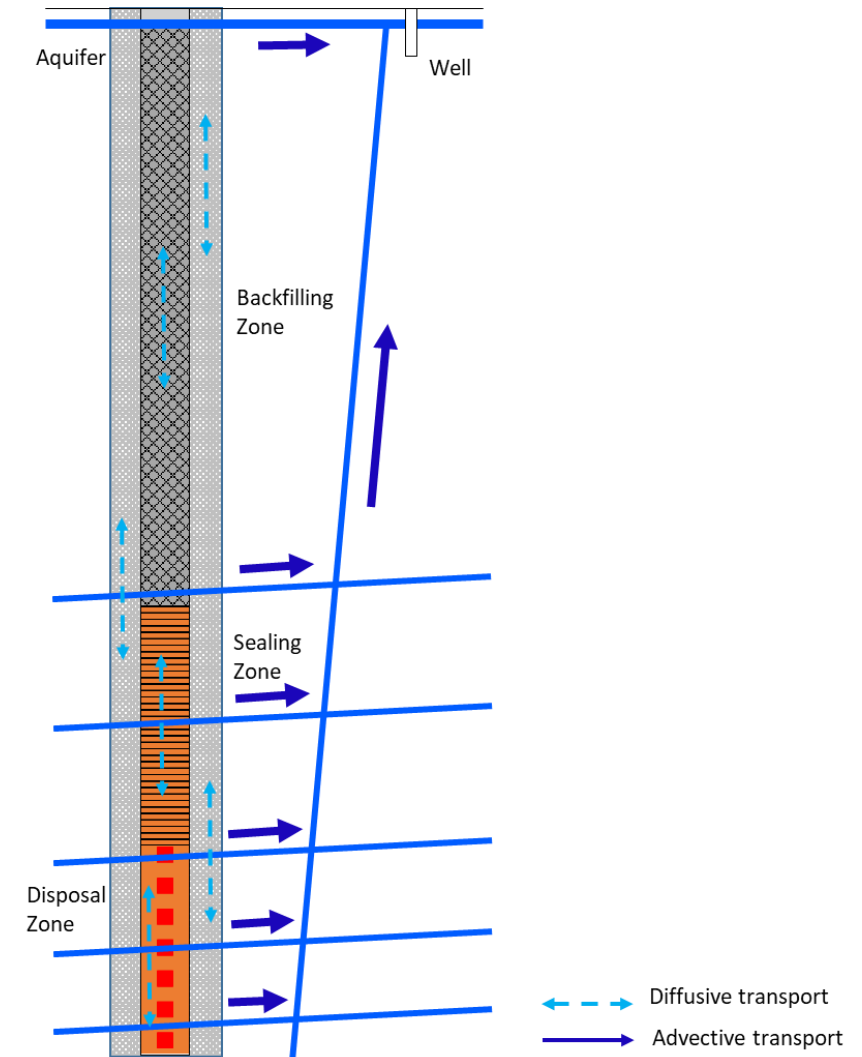
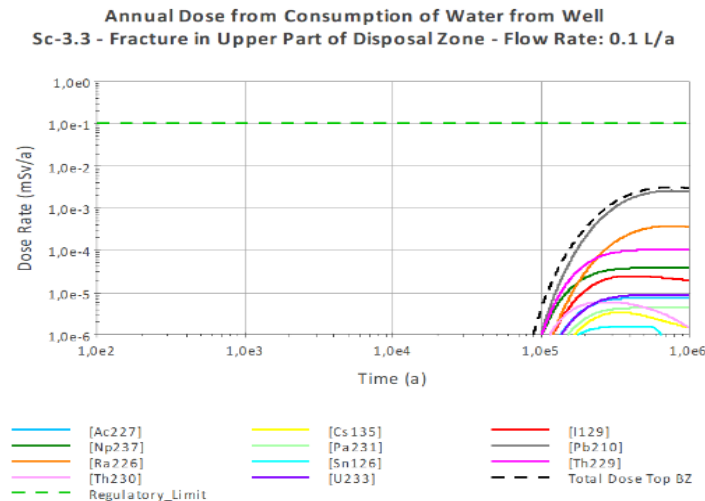

Safety Assessment - Summary

- Based on the safety assessment, DBD is a very good option for the long-term isolation of radionuclides
- For the normal evolution scenario (SC-1), the calculated dose rates are more than 20 orders of magnitude below the regulatory limits
 - In none of the considered scenarios, the regulatory limit of 0.1 mSv/a was exceeded



Thank you for your attention!